

SCHWEISS DOORS

HYDRAULIC DOORS

- Farm Doors
- Barn Doors
- Commercial Doors
- Designer Glass Doors
- Airplane Hangar Doors

BIFOLD DOORS

INDEX	Page
Door Comparisons	1-6
Lift-Strap Bifolds	7-10
Strap Latches	11-12
Cables VS Straps	15
Greasable Hinges	16
Hydraulic Doors	17-18
Hydraulic Hinges	19
Hydraulic Power Unit	20
Wind Pins and Remotes	21
Insulation Package	22
Free Standing Headers	25-26
Superstructure Design	27-28
Lower Building Costs	29-30



Updated: 5/2023

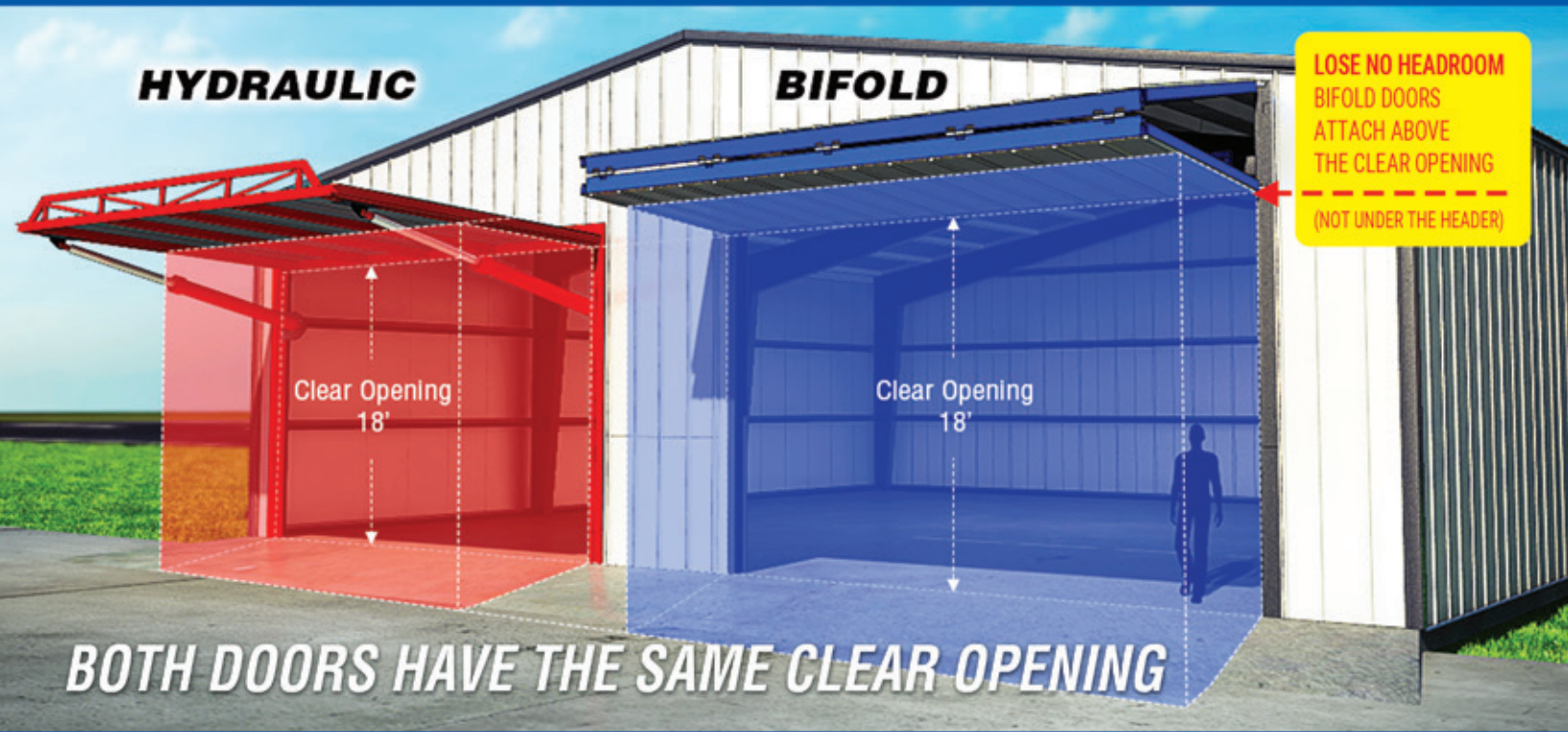

WHY I WENT WITH A HYDRAULIC DOOR

I Like the shade when open!

Swing out when opening.

HYDRAULIC DOORS

Protrude straight out off the building at 90 degrees and lay flat when fully open.

TRAVEL COMPARISON

Hydraulic Doors swing outwards when opening. Hydraulic doors require more/greater space in front of the doorway for the door to travel outward.

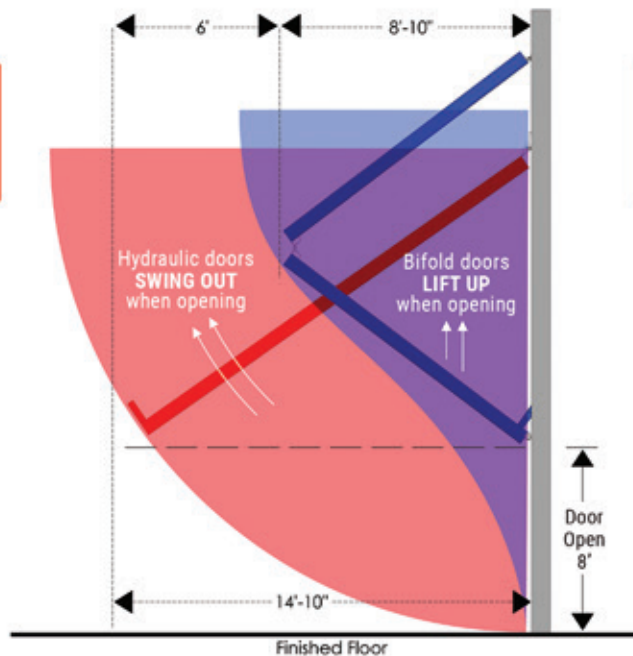

WHY I WENT WITH A BIFOLD DOOR

We needed all the parking space we could get!

Lift up when opening.

BIFOLD DOORS

Fold in half when open putting less stress on the building and create a slight slope allowing water to run off.

SPACE SAVER

- The fact that bifold doors fold in half instead of just swinging out, allows for more open ramp/vehicle space in front of the hangar. It also allows the full use of the width of the hangar, making the entire end wall a door.

NO NEED TO MAKE THE BUILDING TALLER... THE BUILDING TALLER...

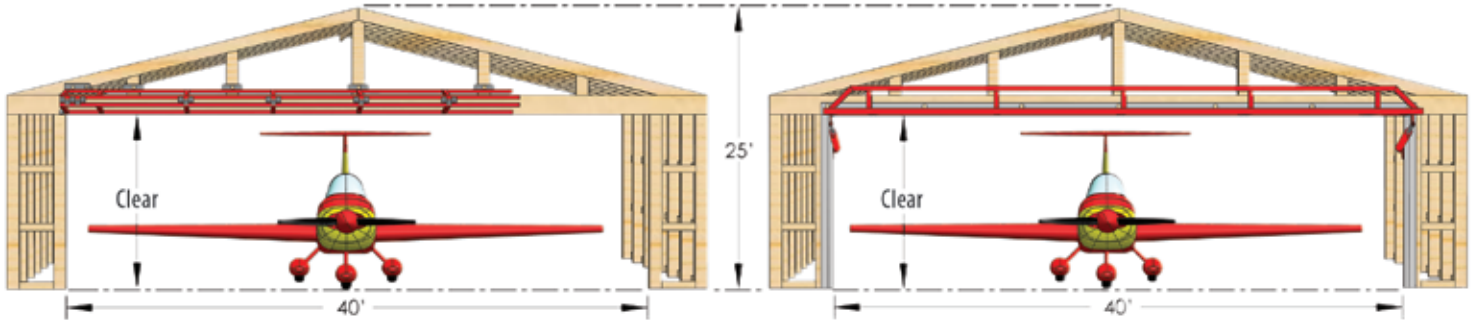

BIFOLD DOORS

Mount "ABOVE" the building header

HYDRAULIC DOORS

Mount "UNDER" the building header

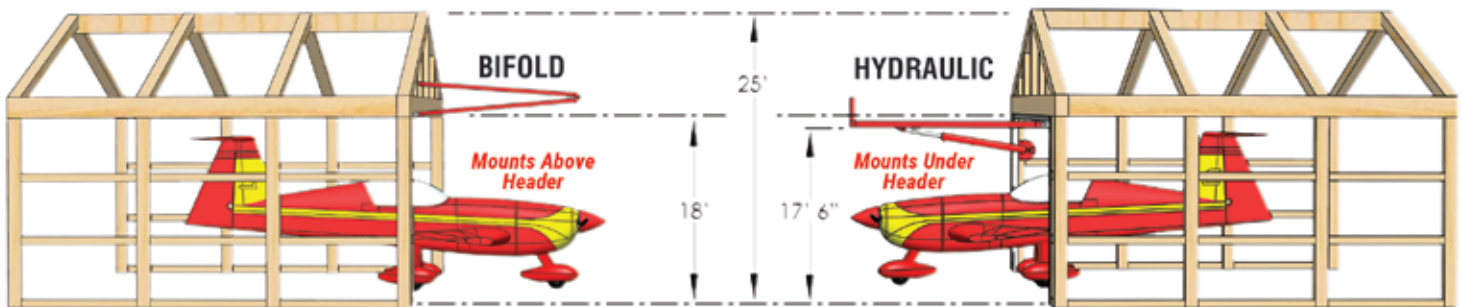

90% of the Bifold doors sold get mounted above the header

80% of the Hydraulic doors sold get mounted under the header

NO NEED TO MAKE THE BUILDING TALLER!

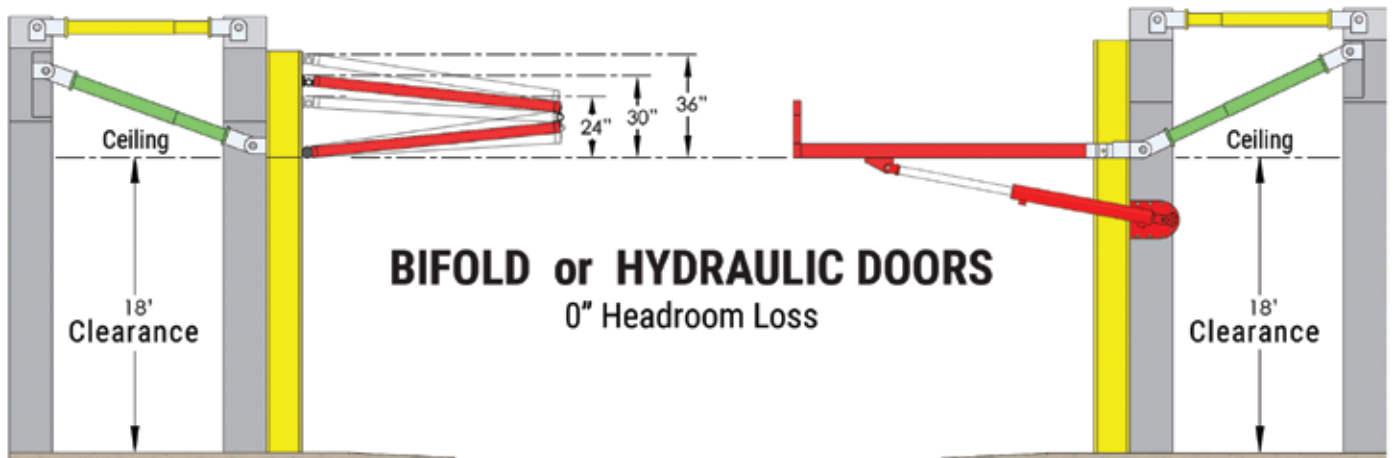

WHERE YOU ATTACH THE DOOR MAKES ALL THE DIFFERENCE...

PARKING & TRAVEL

COMPARISON

HYDRAULIC
DON'T PARK TOO CLOSE!



BIFOLD
PARKING NOT A PROBLEM



HYDRAULIC DOORS SWING OUT AS THE DOOR OPENS

BIFOLD DOORS LIFT UP AND OUT AS THE DOOR OPENS

- Hydraulic doors swing out when opening.
- Requires a stay-back area for parking.
- More swing.

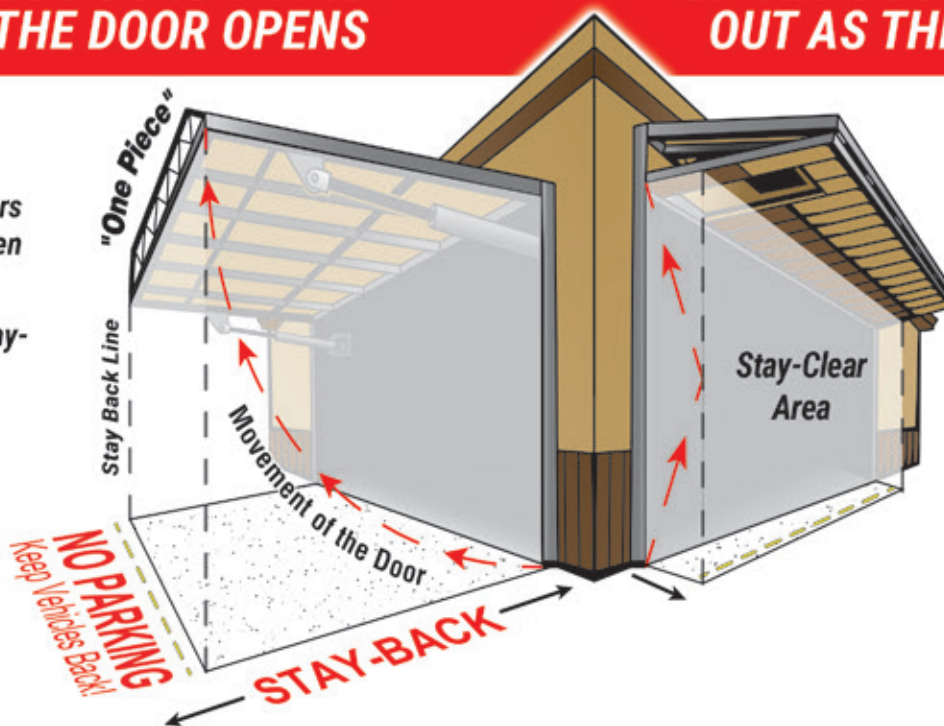

- Bifold doors lift up when opening.
- Parking not an issue.
- Less swing.

DOOR SLOPE

COMPARISON

BIFOLD DOORS

BIFOLDS HAVE A NATURAL SLOPE

Bifold doors have a 1:12 natural slope when in the open position. The sheeting on bifold doors allow water and snow to easily drain off the door in any position!

Bifold doors open to the full clearance while still having a slight slope in the full-open position allowing proper drainage.

HYDRAULIC DOORS

A SLIGHT SLOPE IS RECOMMENDED

"One-Piece" doors should have a slight downward slope when open to direct moisture and water off the door sheeting. This prevents moisture and water from seeping under the door sheeting and ruining the interior door insulation.

Hydraulic doors lie flat 90° when in the full-open position. Water and snow can build up when left fully open!

Water damage may occur to insulation and hydraulic door if precipitation rests on top of fully opened door!

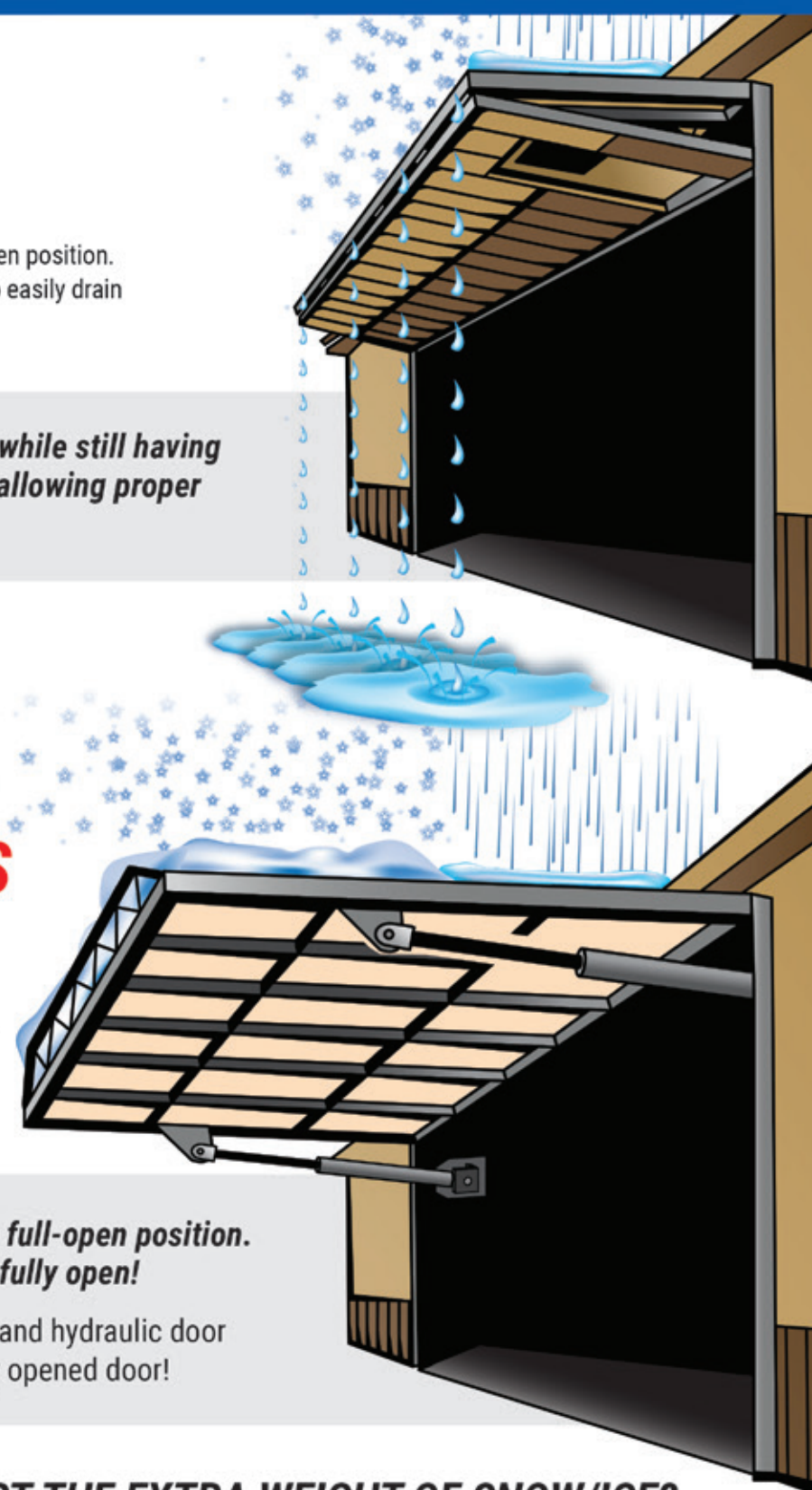

WILL YOUR BUILDING SUPPORT THE EXTRA WEIGHT OF SNOW/ICE?

WHICH DOOR DO YOU NEED...?

HYDRAULIC DOOR



“ONE-PIECE” HYDRAULIC DOOR

- Comes complete with its own self-supporting header and frame.
- Swings out and away from the building.
- No lost headroom inside the building.
- Door extends out at a 90° angle off the building.
- Must park further away from the building.

EACH DOOR OFFERS SOMETHING DIFFERENT. Each has specific advantages. Tell us your situation so we can better advise you. The bottom line, it's the customer's choice. Only Schweiss Doors gives you that advantage. Schweiss Doors already has a long history in the door world. We are the first choice for thousands of customers and our Hydraulic Doors are creating great interest. With either door, you get Schweiss Quality. Talk with us first and we can make your decision easier... Hydraulic or Bifold!

IT'S THE CUSTOMERS CHOICE!



BIFOLD DOOR

LIFT-STRAP BIFOLD DOOR

- *No need for subframe.*
- *Door lifts up when opening.*
- *No lost headroom inside the building.*
- *Door folds in half and doesn't hang out as far.*
- *Still able to park close to the building.*

The choice is yours...

"You decide which door works for you."

LIFT-STRAPS

BETTER THAN CABLES

Some manufacturers still continue to try and sell out-dated cable lift bifold doors - cable doors that not only require frequent maintenance due to fraying, breaking and overwrapping, but which also open much slower, are hard to adjust, are not as safe as straps, and are noisier than lift-strap doors.

LIFT-STRAPS ARE:

- EASY TO INSTALL
- LONGER LASTING
- QUIETER
- FASTER
- SAFER



CUSTOMER'S WORDS:

"I am in the process of bidding a hangar and need a bifold door quote, 32' clear length. The bid package states that only lift-straps, not cables are approved. Please send specs and cost. Thank you."

FAST MOVING **BIFOLD DOORS**

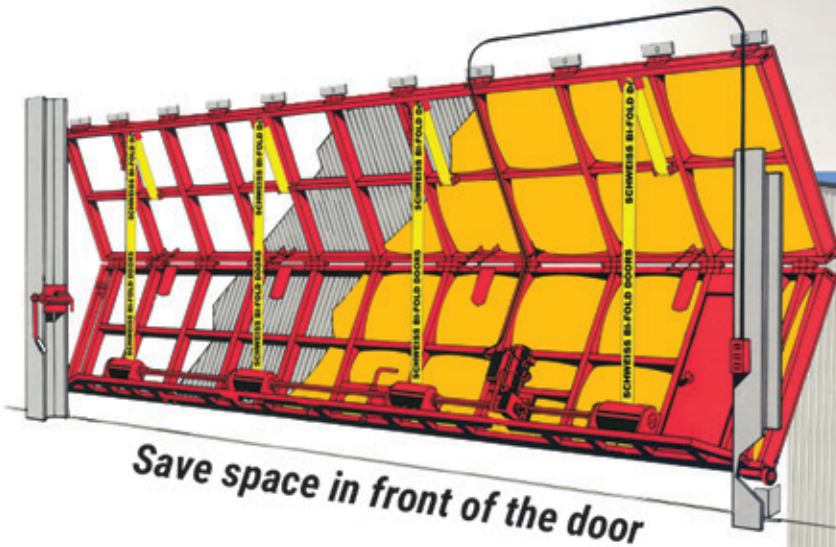
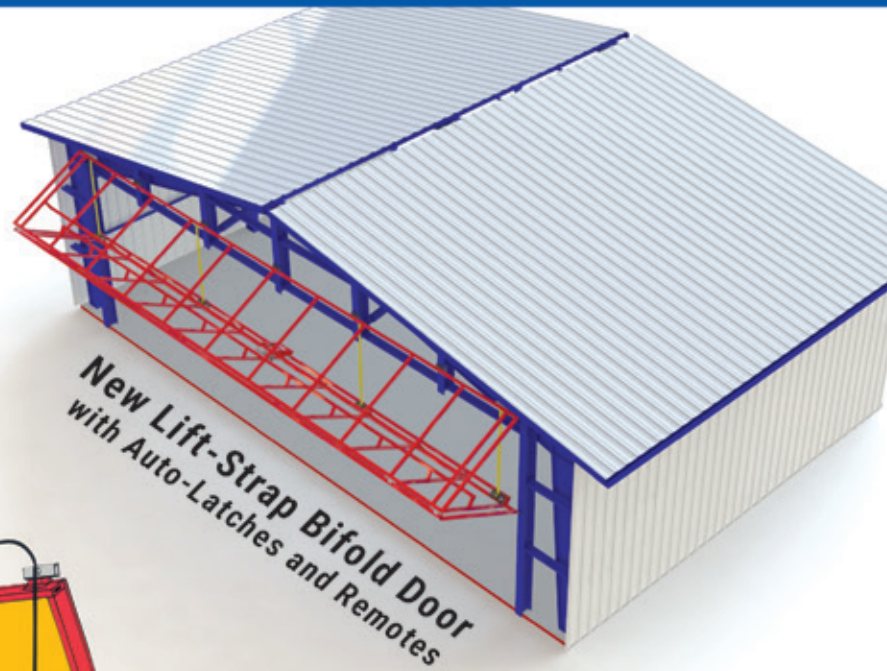

EVERYBODY WANTS THE DOOR WITH LIFT-STRAPS

Here's what customers are saying about their strap bifold doors

"The lift-straps work good and lift faster - the cables were so slow, the door works great now."

"I'm thrilled with lift-straps, they're great, and they open my door 10 times faster than before. I absolutely will recommend them to everyone."

"The decision to get lift-straps on my bifold door was more of a safety issue for me."

"I can't say enough about your lift-straps, I wish I'd done it originally."

"A lot of guys are coming to look at our door. I'm sure you'll be selling more Lift Straps, we like 'em!"

"Straps are the only way to fly. No noise, no creaks, no crunches. Cables wear out."

"Cables were breaking on our big hangar door and we knew the lift straps were a better system."

"Our door with lift-straps now works really well - a 100 times better than before. Our cables broke on us and that was a mess."

"We converted to lift-straps for reliability and aesthetics."

ORDER YOUR NEXT SCHWEISS BIFOLD DOOR

WITH THE NEW LIFT-STRAPS

ADVANTAGES OF LIFT-STRAPS

- **Quieter**
- **Easy to install**
- **Safer**
- **Last longer**
- **Faster**
- **Easy to maintain**

LIFT-STRAPS ARE BETTER THAN OUTDATED CABLES

Some manufacturers still continue to try and sell outdated cable lift bifold doors - cable doors that not only require frequent maintenance due to fraying, breaking and overwrapping, but also open much slower, are hard to adjust, are not as safe as straps, and are noisier than lift-strap doors. **Straps keep going and going and going.**

Straps are rated for 29,000 lbs. each

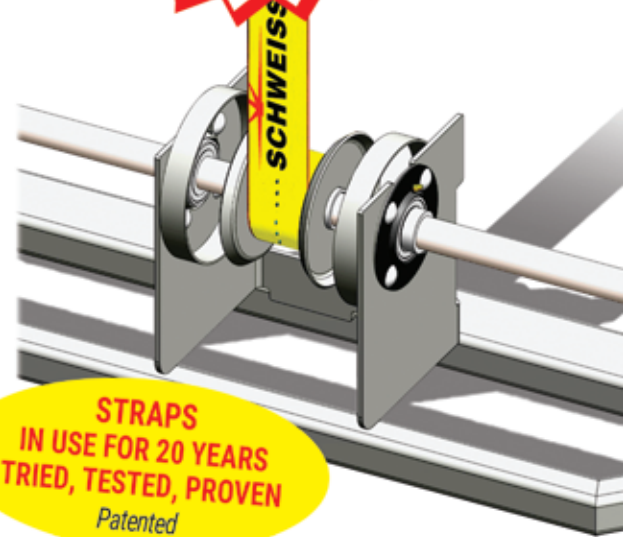

OTHER CABLE DOOR MANUFACTURERS ARE FIGHTING BACK...

THEY ADD NUMEROUS LIFT POINTS

The only reason a cable door manufacturer would add more cable lifts to a door is because cables are not as strong as lift-straps. More cable lifts means more maintenance, more expense - why fight the outdated cable concept and costs involved! Using more cables may translate to less load per cable, but who wants more cables if cables are already known to cause headaches and loss of time to replace (they are known to break when you least want them to, for example during harvest, in 20-below weather, etc.)

THEY OFFSET THE CABLES AS THEY WRAP UP ON THE LIFT DRUM

Offsetting the cables during lifting of a bifold is a great concept, until your cables don't have the proper tension. Then you end up with messed up cables again! Unlike straps that wrap on top of each other. Tension is never an issue with lift-straps nor do they get messed up. Straps are a perfect design... trouble free. Using lift-straps saves you from all those headaches.

It used to be that cables were your only option...

Straps eliminate all the cable problems that bifold customers have lived with for years.

WHY WOULD ANYONE WANT A CABLE DOOR WHEN YOU CAN GET STRAPS?

A BETTER SOLUTION...

LIFT STRAPS ARE A MARKET SHAKING INVENTION!

The most obvious "market shaking" improvements for the Schweiss Bifold Door is the addition of the patented lift-straps along with the new strap autolatch systems, two features not offered by any other door manufacturer. Schweiss lift-straps have revolutionized the door world by opening and closing much more quickly, quietly and effortlessly. Not only are they safer, but they're also easy to install and much longer lasting. It's a win-win for the customer and strap doors are leading the market in the door world. Schweiss Patented Lift-Straps!

Schweiss Doors of Fairfax, Minnesota, USA have been on the market for over 40 years. We manufacture two great styles of doors, the Schweiss Hydraulic Doors and the famous "Lift-Strap" Bifold Doors. What some people don't know is that Schweiss Bifold Doors evolved with the times and many improvements have gone into them, creating a product that everyone is wanting!



P. S. Has anyone ever converted a strap door back to cables . . . I don't think so!

Once You Try "Lift-Straps" You'll Never Go Back to Cables

Schweiss's excellent success with the New Lift-Straps has revolutionized the door industry. It's a no-brainer. Why bother with cables? It becomes obvious when you understand why the new patented Lift-Straps are the smarter way to raise and lower your bifold door. Smoother, safer, faster and quieter. Like a customer once said, "My strap bifold door is the envy of my fly-in community. I'm happy I bought the Schweiss Door!"

Tested and Proven... Lift-Straps

For years, bifold doors have been lifted and lowered by the conventional means of steel cables. Schweiss Doors have been using the popular, long-lasting lift-straps for over 20 years. Now 99 percent of our customers are demanding polyester lift straps for this function. Why? Because lift straps offer more lifting ability, won't fray or overwrap! The strength-to-weight ratio on straps is extremely high. The 3-inch straps are rated at 29,000 lbs, where 1/4" cables are rated at only 7,200 lbs. In addition, the safety factor on straps is well over the standard 5:1 ratio.

AVAILABLE FOR **BIFOLD DOORS**

THE NEW AUTOMATIC **STRAP LATCH**

This is what every door owner wants and needs. Unlike other latch mechanisms, the new design will firmly hold the door against your building in all positions; securing the door when open/partially open and will firmly lock the door when closed. It will offer added protection from wind gusts while the door is in any position during operation.

SCHWEISS "ALL-STRAP" BIFOLD DOOR - NO CABLES USED AT ALL



STRAP LATCH
SCHWEISS IS THE ONLY
MANUFACTURER
OFFERING AN ALL-
STRAP DOOR

STRAPS DO ALL THE LATCHING

*" THE CONCEPT IS SO SIMPLE...
I CAN'T BELIEVE WE HAVEN'T THOUGHT
OF THIS BEFORE! "*

- Straps secure the door in the open position.
- Straps secure the door in the closed position.
- Adds protection from wind gusts while in operation.
- Latch Straps are rated for 29,000 pounds.

NOW STRAPS DO THE LATCHING

AN ALL STRAP BIFOLD DOOR . . . NO MORE CABLES!

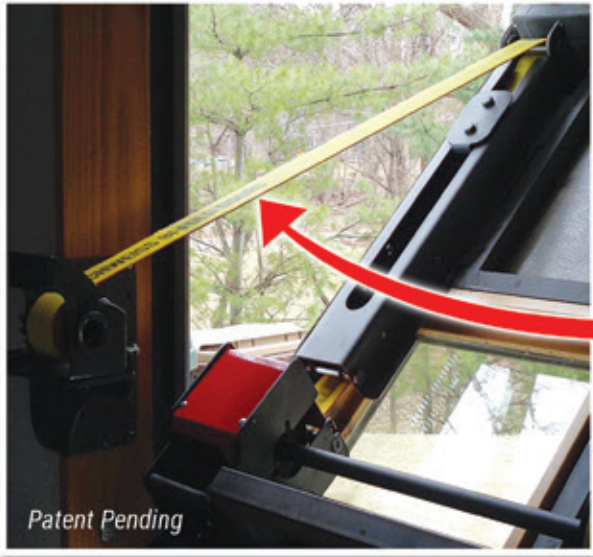

THE SIMPLICITY OF THE NEW LATCH STRAP IS TRULY AMAZING! Straps do the lifting and now straps do the latching! Schweiss did away with all the cables, chains, sprockets and pulleys; and it now has 90 per cent less moving parts. This is a real game changer in the bifold door world! It doesn't get any better than an all-strap door.

**Everybody wants Strap Latches
With REMOTE CONTROLS!**

STRAP CLEARANCE DETAIL

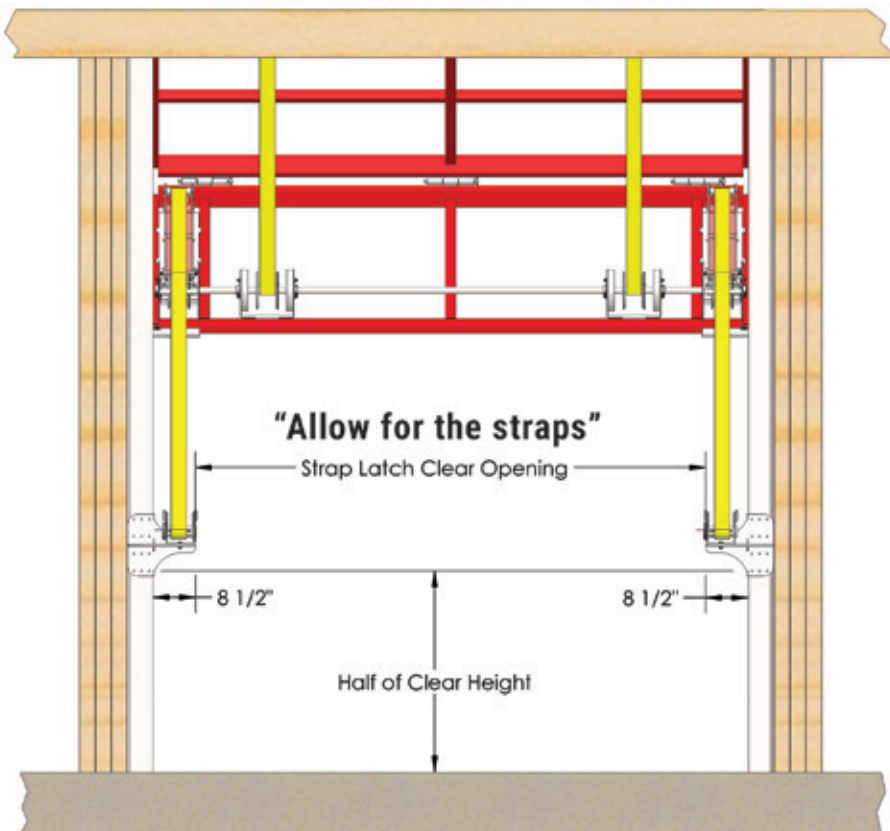

SCHWEISS BIFOLD DOORS KEEP GETTING BETTER!

SCHWEISS **CUSTOMER**

BIFOLD DOOR **PHOTOS**



Bifold Door Testimonial

"I like liftstraps because they are faster and safer than cables. The autolatches work great! Once they are latched, they are latched! – and it is a positive secure latch!"

Jim Becke



Bifold Door Testimonial

"Schweiss installed the two bigger doors, we hung the other ones. We walked our way through the install book; it was very simple. We chose bifold doors for the shorter canopy and they are a lot better for snow conditions."

Brian Ryberg



Bifold Door Testimonial

"When I heard Schweiss bifold doors went to straps instead of cables, it was a no brainer. I knew there would be less maintenance. It works every time, all the time."

Lonnie Spaeth





Testimonial

"One thing about the Schweiss doors is they keeps improving them all the time. I see Schweiss now has new wrap-around hinges that are welded to the door better." Paul Lux

Testimonial

"Schweiss is a phone call away with an outstanding support group that will help with any technical question or problem on the spot. Schweiss stands behind their doors"



Testimonial

The Schweiss Door price was very good compared to all the others. Some of the other dealer prices weren't too bad, but they tried to jack it up on the shipping and stuff."

Steve Welch, Maine

Testimonial

"I wanted a big door and Schweiss talked me into getting an even wider door, and I'm very glad they did that. Equipment keeps getting bigger; it doesn't get smaller." Dennis Peterson



CABLES vs. LIFT-STRAPS

OTHER CABLE DOOR MANUFACTURERS ARE FIGHTING BACK

By offsetting the cables as they wrap up on the lift drum.

Offsetting the cables during lifting of a bifold is a great concept, until your cables don't have the proper tension. Then you end up with messed up cables again! Unlike straps that wrap on top of each other . . . Tension is never an issue with lift straps nor do they get messed up. Straps are a perfect design, trouble free . . . using lift straps saves you from all those headaches.

By adding numerous lift points

The only reason a cable door manufacture would add more cable lifts to a door is because cables are not as strong as lift straps. More cable lifts means more maintenance, more expense why fight the outdated cable concept and costs involved! Using more cables may translate to less load per cable, but who wants more cables if cables are already known to cause headaches and loss of time to replace (they are known to break when you least want them to, for example during harvest, in 20-below weather, etc.)

What cable door customers are saying :

With cables, you have to deal with the cable clamps - proper tension on the cables is critical! More maintenance, shorter working life and cable doors are slower . . . Cables wear out sooner and are not as safe as straps.

Straps are a better design that solves all the outdated cable door issues

Schweiss Lifts straps have proved to be by a far superior method of lifting any bifold door. Lift straps wrap on top of themselves by design. No worry with overlapping issues or with cables rubbing against each other. Furthermore, everyone knows that cables are not even close to being as quiet as liftstraps. Can you imagine the noise 10 or even 50 cables must make?

STRAPS ELIMINATE ALL THE CABLE PROBLEMS THAT BIFOLD DOOR CUSTOMERS HAVE LIVED WITH FOR YEARS.

STRAP CONVERSION KITS:

"Yes, Strap Conversion Kits are available. The word is out!"

Schweiss will do strap conversions on other brand bifold doors, no matter the make or model. Schweiss has received thousands of calls from existing outdated cable bifold door owners wanting to retrofit their outdated cable door system to the "Schweiss Patented Liftstraps "

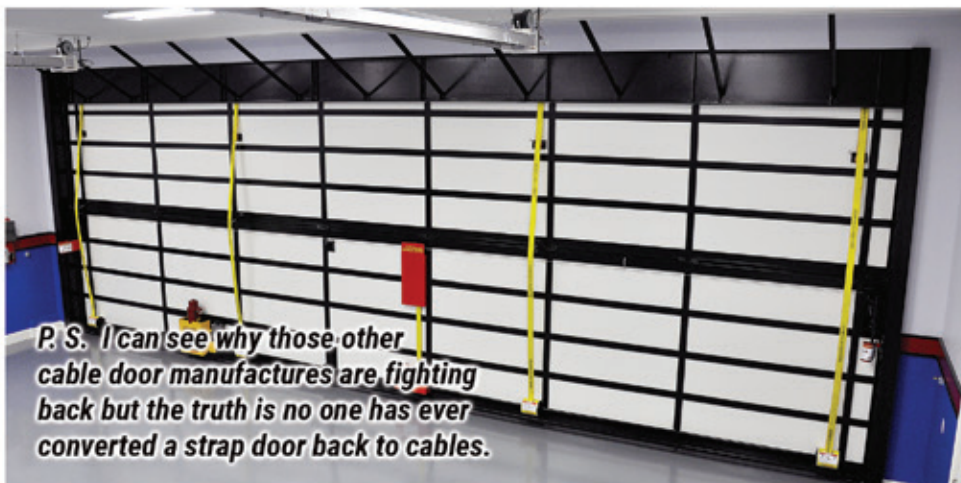

Straps are rated for 29,000 lbs. each

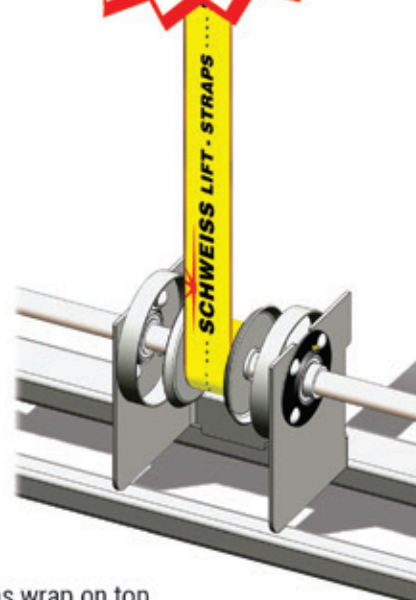

NEW **GREASABLE HINGES** ON EVERY SCHWEISS DOOR

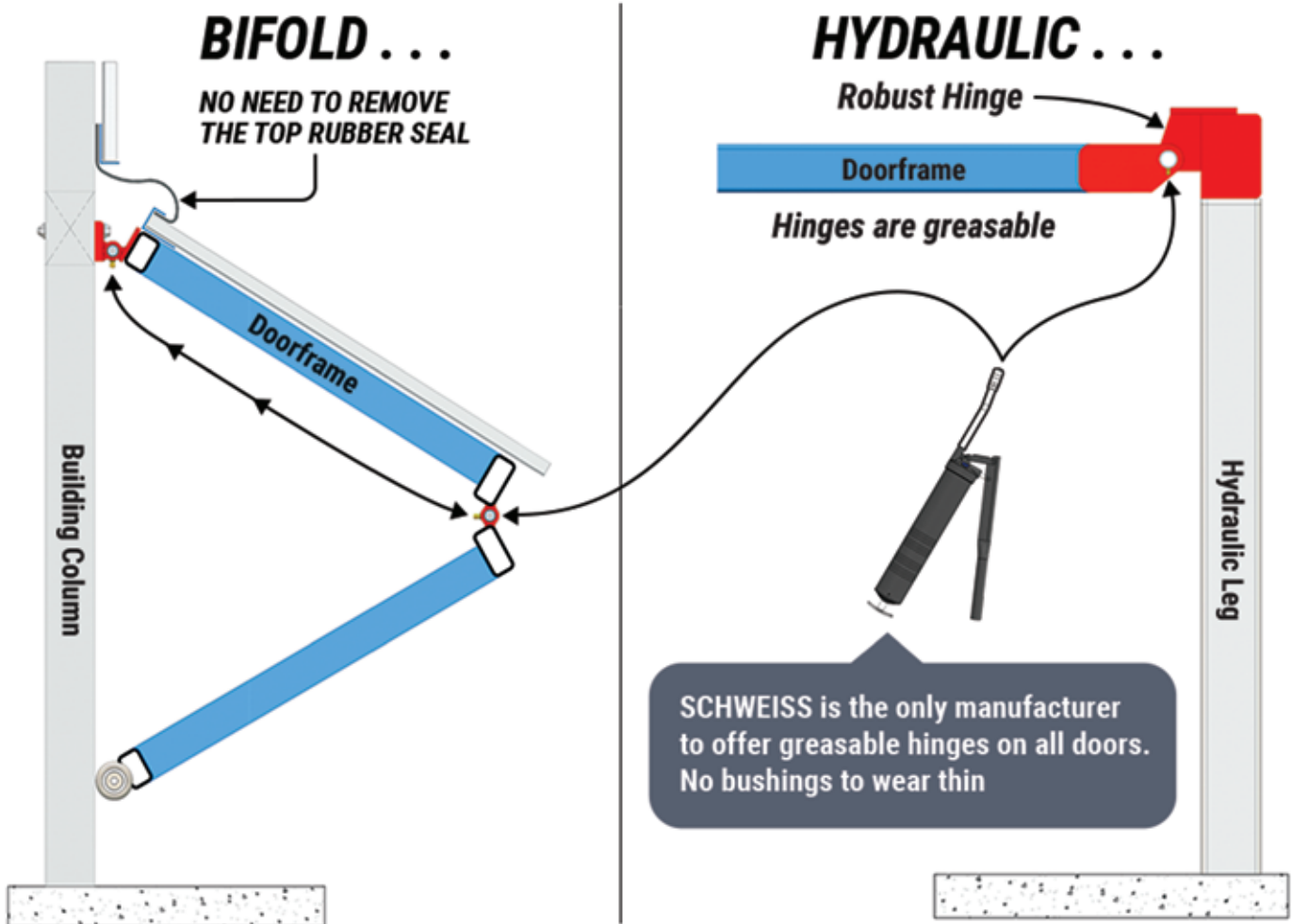

GREASABLE HINGES LAST FOREVER!

Hinge pins are removable, not welded in . . . No bushings to wear thin!

Schweiss Doors didn't just wrap our head around heavy-duty door hinges, we went a step further and engineered a robust, user-friendly, greaseable hinge with a removable hinge pin.

The new hinge design, with grease zerks on every hinge segment enables bifold door owners—whether they be private individuals or commercial customers—to periodically grease their hinges from the underside of the doorframe without having to go through the cumbersome process of first removing the top rubber weather seal.

Schweiss Doors is the only door manufacturer to offer easily accessible greaseable door hinges for bifold and hydraulic doors that can be greased from the underside of the door without removing the top weather seal.

CUSTOMERS WELCOME GREASEABLE HINGES!

MAKES SCHWEISS DOORS BETTER!

SCHWEISS BUILDS THE BEST **HYDRAULIC DOOR**

DOORS ARE ALWAYS MOVING AND FLEXING

Spherical bearings reduce stress and wear on the cylinders, cylinder pins and clevises during operation. "No one else in the industry offers this unique feature", included on every Schweiss hydraulic doors...



**Lose No Headroom...
ANY SIZE DOOR!**

SPHERICAL BEARINGS

Hydraulic doors are large in size and just like an airplane wing, the doorframe flexes during operation. The hydraulic cylinders on each side of the doorway are connected to the doorframe and the building using spherical bearings. The spherical bearings accommodate the flexibility of the doorframe while at the same time allowing the cylinders to raise and lower the door without binding on the hydraulic cylinder pins and brackets. Spherical Bearings on both ends of the cylinder allow the cylinders to stay straight through the full range of motion.

Allows for Flexing

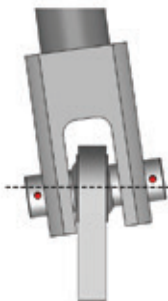

Stays Straight

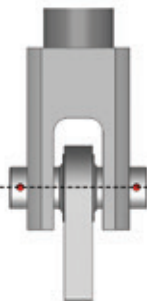

Allows for Flexing

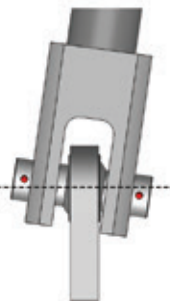

Rod stays straight.

Pins have even forces on them when the door is in any position.

Lower teardrop plate is mounted to moving doorframe.



STRONG WORDS FROM OUR CUSTOMER

"Soon as I saw and understood the spherical bearings design it was a no-brainer. I was immediately SOLD on the Schweiss Hydraulic Door!"

BIG . . . CLEAN . . . BEAUTIFUL

"One-Piece" HYDRAULIC DOOR DESIGN

- **DOUBLE PUSH TUBES**
- **FAST OPENING SPEEDS**
- **QUIET, SMOOTH OPERATION**
- **LARGE HYDRAULIC CYLINDERS**

MANY HINGE POINTS . . . STRONG FRAME DESIGN . . . SOLID DOOR

**Splice
Connection**



CLEAN LOOK

EASY TO INSTALL

NEW STRONGER HINGE DESIGN

ON ALL SCHWEISS HYDRAULIC DOORS

“OUR NEW WRAP-AROUND HINGE DESIGN SETS THE NEW STANDARD FOR HYDRAULIC DOORS”

Schweiss doorframes are designed with triple push tubes that are tied directly into the wrap-around hinges that connect each vertical push tube directly to the header tube. The advantage of triple push tubes is that forces of hydraulic cylinders are evenly distributed to the doorframe and the wrap-around hinges.

“There have been hydraulic doors with hinge welds that failed, literally tearing off the doorframe and destroying the door,” Schweiss says. “Our design team provided a durable wrap-around hinge with grease zerks that are accessible without removing the top rubber seal.”

EVERY DOOR HAS ITS OWN SELF-SUPPORTING SUBFRAME

Schweiss hinges distribute the door loads evenly across the self-supporting subframe greatly reducing stress on the building structure.

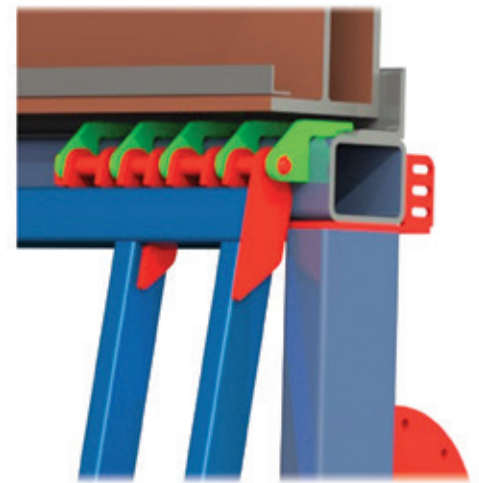

WHAT DOOR CUSTOMERS ARE SAYING

- “The hinges sold me.”
- “The Schweiss team hit a home run by putting grease zerks in their hinges.”
- “Now that’s a serious hinge, You guys have it figured out!”
- “Oh my, nothing comes close to it. Professionally done!”
- “Nothing on the market even comes close to the Schweiss hinge design.”

GREASE ZERKS ON ALL HINGES

Hinges can be greased from underneath the door.

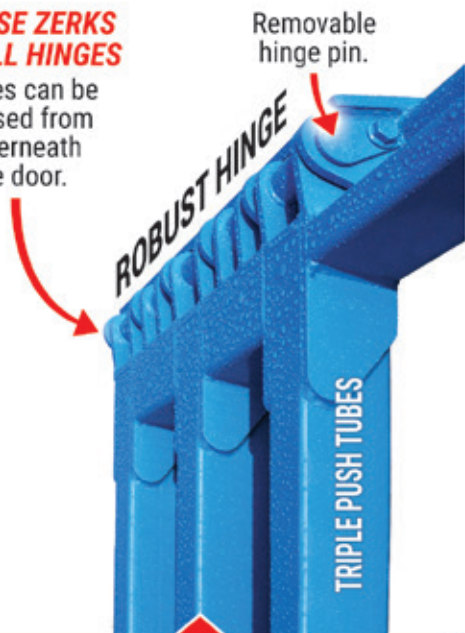

TRIPLE PUSH TUBES

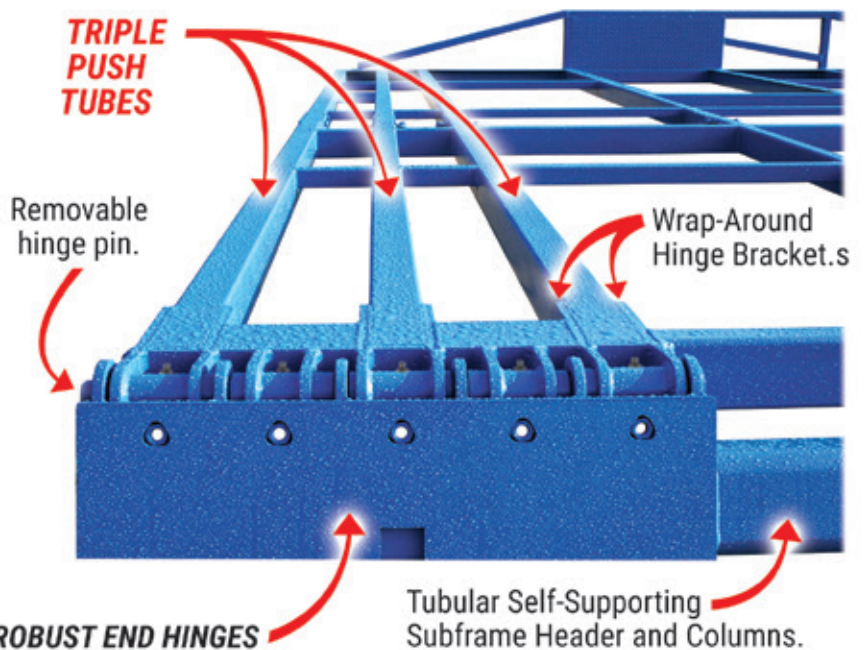

ROBUST END HINGES

Tubular Self-Supporting Subframe Header and Columns.

SCHWEISS is the only manufacturer to offer hinges that can be greased from underneath the door without removing the top weather seal.

Heavy-Duty Hinges

HYDRAULIC POWER UNIT

ALL-IN-ONE COMPLETE UNIT

- Operates two heavy-duty lift cylinders.
- Self-contained electric / hydraulic power unit comes from the factory fully assembled and ready to operate.
- Each unit comes pre-wired and factory tested, complete with a 24 V.A.C. control system.
- Each power unit has an oil reservoir (4 or 8 gal.), and a direct drive motor to the hydraulic pump protected by an oil filter (standard on all models) complete with gauges.

BACK-UP SYSTEMS

- Drill-driven back-up to raise or lower the door.
- Tractor back-up fittings built-in.
- 12V Battery back-up with remote.
- Self-contained aux. pump and motor in tank!



Every doorframe has a self-supporting subframe. Fast and easy to install!

SCHWEISS
DOORS

AUTOMATIC WIND PINS & REMOTES



AUTOMATIC HYDRAULIC WIND PINS

It is no longer necessary to manually retract the wind pins before operating the door. Automatic hydraulic wind pins are an important feature for any customer who wants the convenience of remote control operation on any hydraulic door but still needs the security of wind pins.

WITH REMOTE CONTROLS

Remotes let you open/stop/close your Hydraulic Door from any vehicle. Automatically unlatches the door so it can be opened or closed with the handheld remote. Two handheld remote controls and remote external antennas are included with each door.

SAFETY

Automatic controlled doors require special attention for safety. When using radio controls you must have an auto latching system or a lock safety switch to eliminate possible damage if the door is opened while in the locked position. All doors equipped with remotes should have a warning system to alert persons in the immediate area that the door is about to open or close.



Remote

SCHWEISS QUALITY

SCHWEISS

INSULATION PACKAGE

NEW

Schweiss Doors, always at the forefront of technology, figured out a better way to insulate your bifold or hydraulic door. Our new Schweiss Interlocking Insulated Panels can be installed quickly and are cost effective solutions for contractors and installers, leaving the end user with a well insulated door that has a super nice glossy white durable finish that will stand up to the elements.



- **EASY TO INSTALL**
- **SAVES LABOR**
- **SAVE YOU MONEY**
- **LOOKS GREAT**
- **INTERLOCKING**

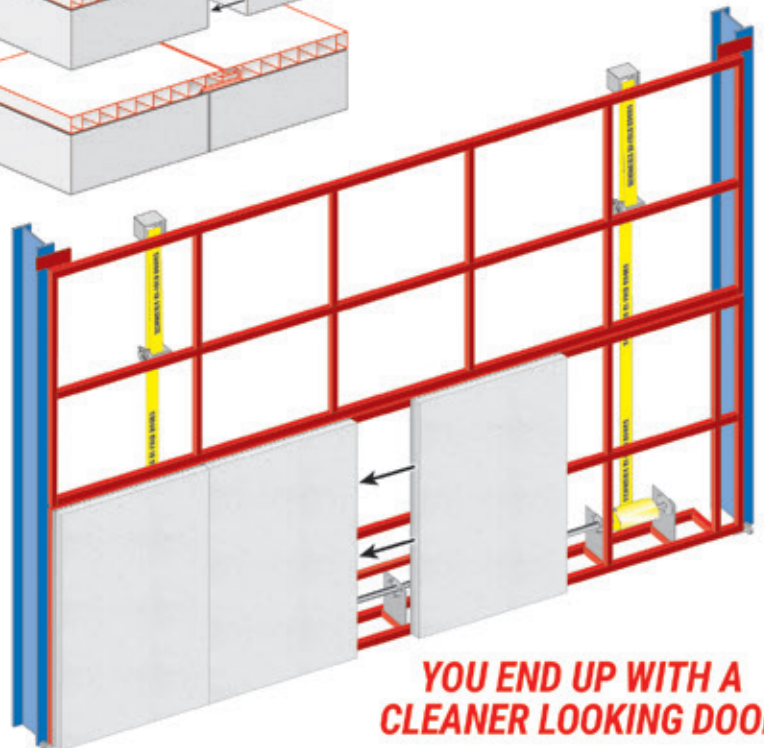
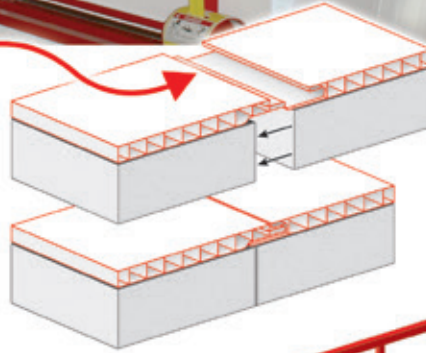

**YOU END UP WITH A
CLEANER LOOKING DOOR**

SCHWEISS **CUSTOMER**

HYDRAULIC DOOR **PHOTOS**



Hydraulic Door Testimonial

The hydraulic door from another company was double the price from the one Schweiss makes and their power unit was off of some car lift thing. The competitors power units were nothing. Why would I buy a rollup door?"

Brian Tavares, Pennsylvania



Hydraulic Door Testimonial

"Our hangar was exposed to 125 mph winds for several hours. Yet that huge Schweiss Hydraulic door did not fail, but a nearby wooden hangar was totally destroyed."

Johnny Smith, MS



Hydraulic Door Testimonial

"Some of the door companies I checked with wanted 30 to 60 percent more for their hydraulic doors. I couldn't see any reason why I should choose them over a Schweiss door."

Jeff Bonebrake, OK



Hydraulic Door Testimonial

"We love the hydraulic door, for architectural design unique application homes it's an ideal product. If a world-class architect specifies you guys, it must be for a good reason."

David Ratzlaff, B.C.



Testimonial

"My company just got word to make Schweiss the recommended door company to do business with on a regular basis and not to do business with the other company."

Craig Uliasz, MA

Testimonial

"My guys, who installed the doors, said the manual that came with the door was very clear and if you followed it step-by-step you couldn't go wrong."

Craig Uliasz, MA



Wood Buildings

Free Standing Header

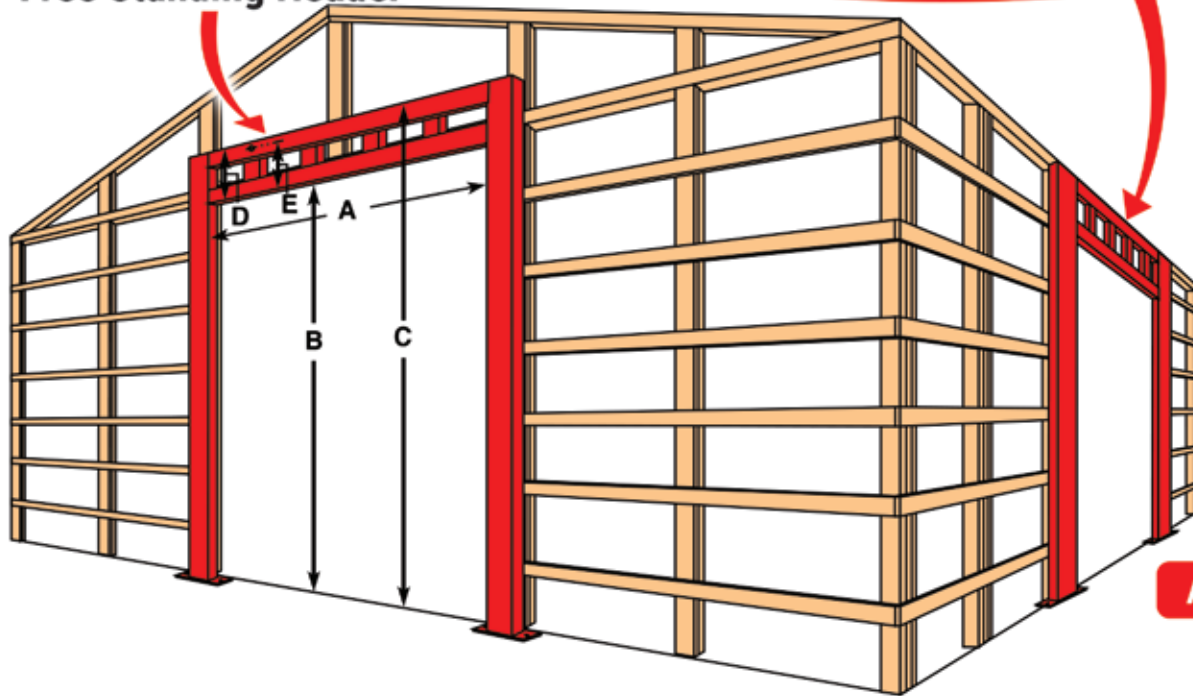

RETROFIT YOUR BUILDING
With Free Standing Headers

Above the Roof-Line

Steel Buildings

Free Standing Header

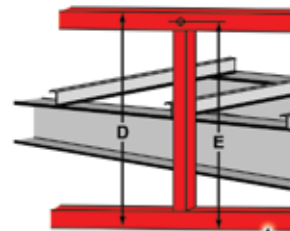
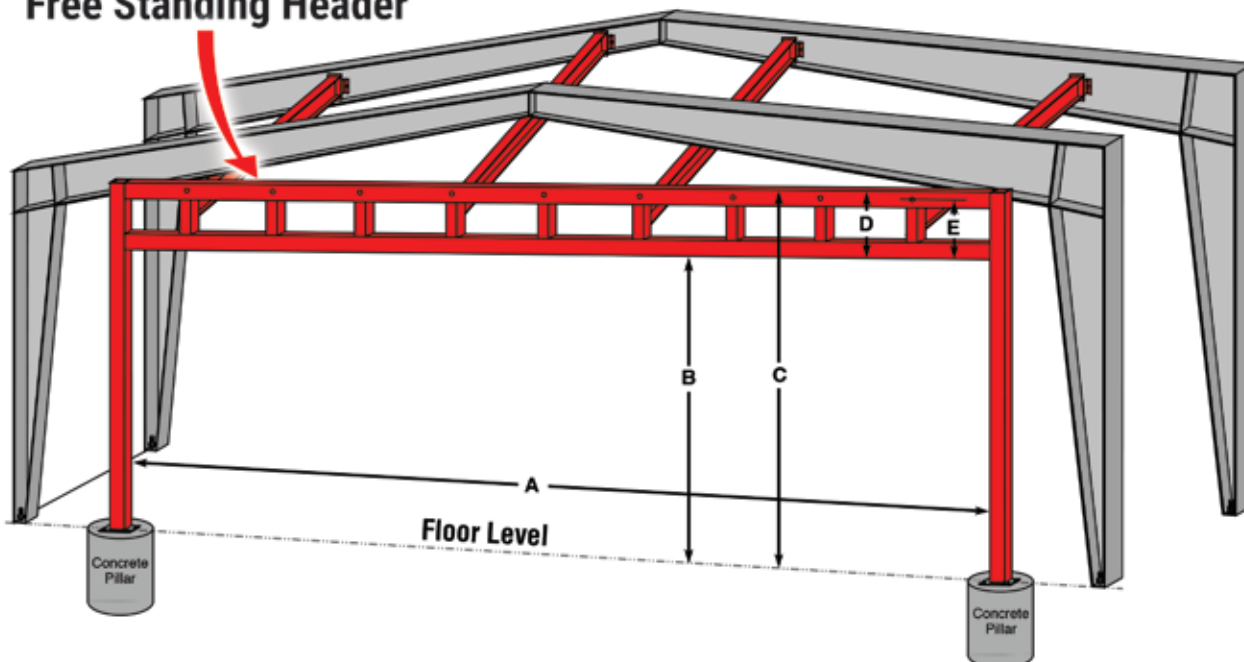

Free Standing Header

To Left Header Leg ← A

Hydraulic Door Header Provides Extra Support

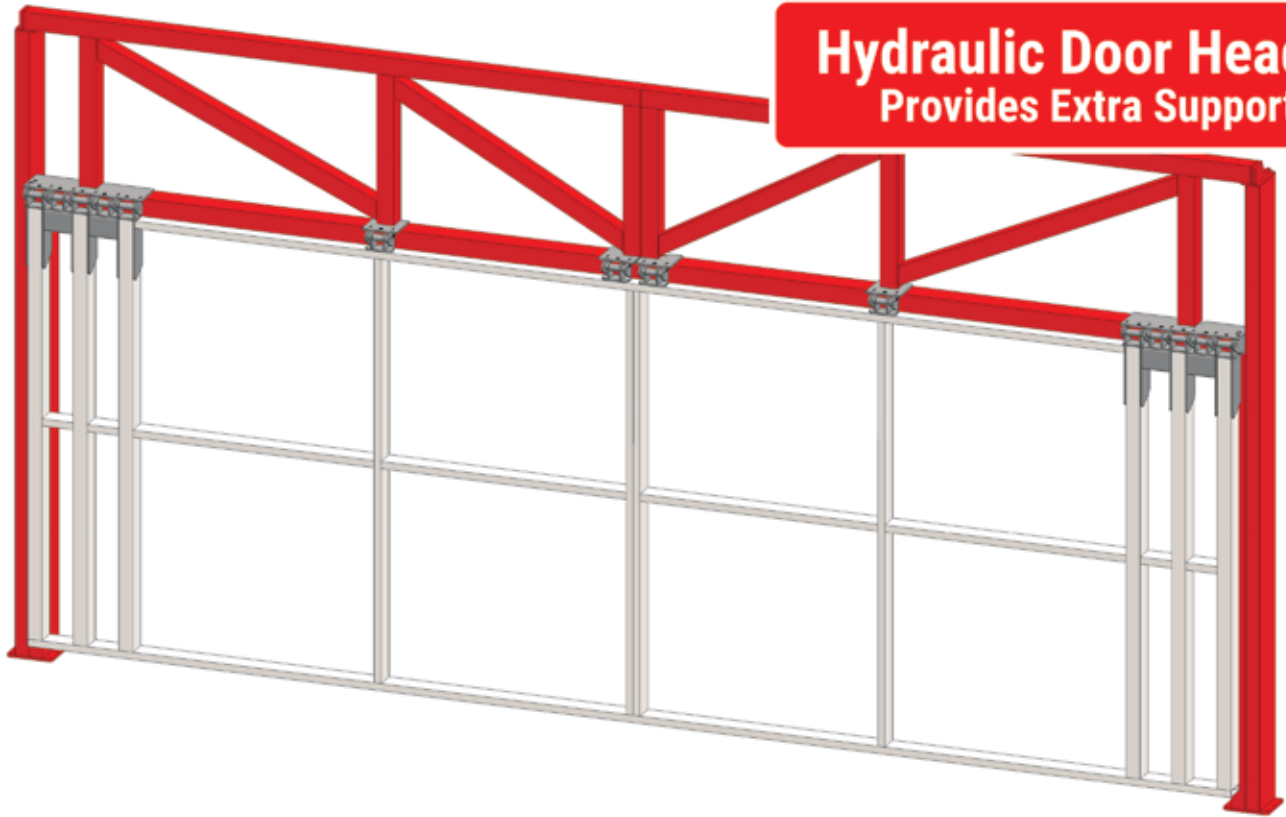

PROVIDES ADDITIONAL BUILDING STRENGTH TO SUPPORT THE DOOR

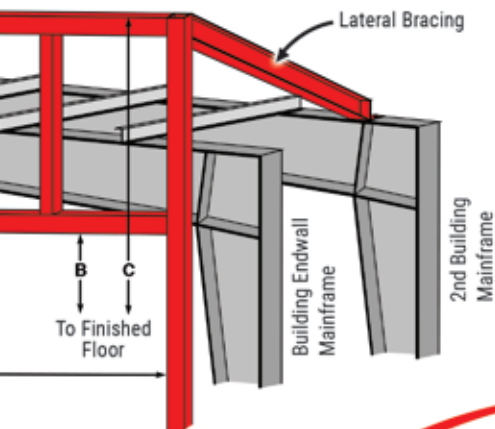

Free Standing Header

Quonset Buildings

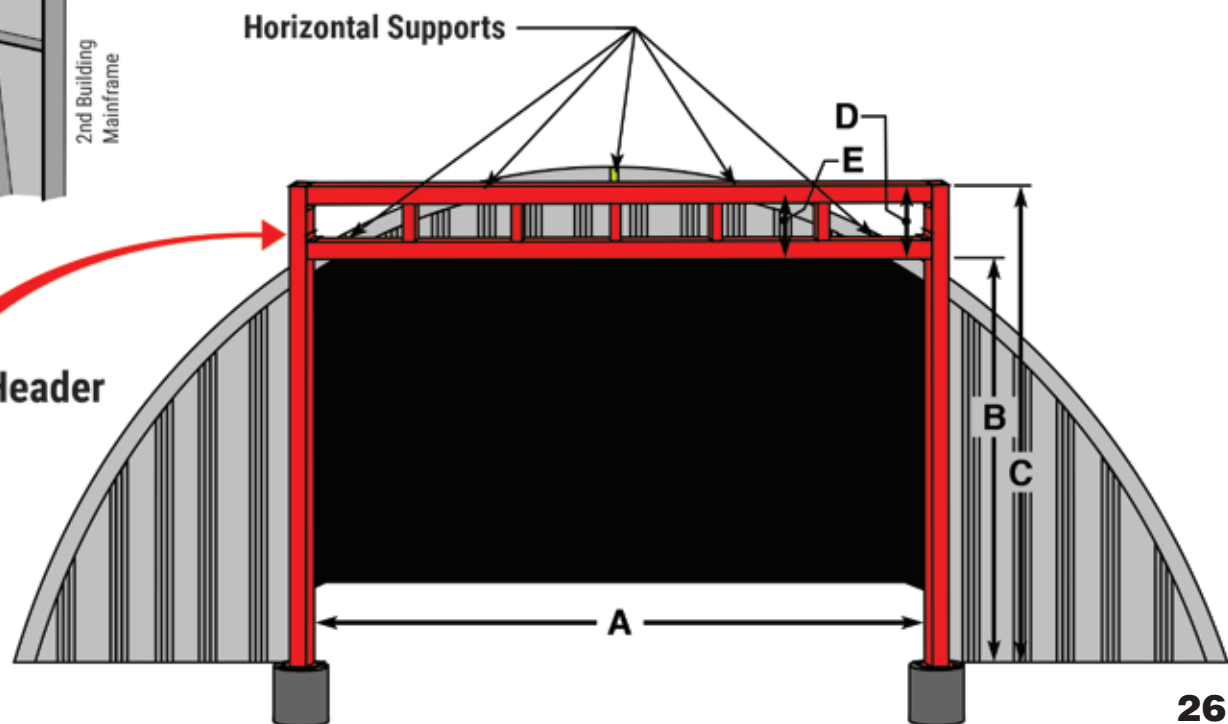

THE NEW **SUPERSTRUCTURE DESIGN** FOR HYDRAULIC

Self Supported Hydraulic Door Design . . . For Your Buildings!

Schweiss has completely raised the bar in terms of hangar doors for general aviation and commercial jet hangars. We apply common sense and an innovative approach to provide you the right hangar door solution for your building. Schweiss realizes it's important to understand what impact the hangar door will have on your building. Schweiss offers all hangar manufacturers choices when designing their buildings.

Schweiss has the capability to manufacture a hydraulic door and framework that's designed to help support the building structure. It is a freestanding hydraulic door that has its own superstructure framework attached and can be added to your new or existing building structure. It's all self-contained so a retrofit is easy. This hangar door is so strong, but yet simple, that it requires nothing more than a common framed opening.

A Schweiss superstructure doorframe mounts on the 'New Stand-Alone "Self Supported" doorframe; eliminating the need for the building manufacture to utilize a building truss or building header to support the hydraulic door on the hangar structure itself. This means you can reduce building costs significantly and gain headroom; saving everyone dollars.

New

Schweiss Superstructure Hydraulic Door Design

What Door Customers are Saying...

- "You guys got it figured out!"
- "Schweiss has a terrific door."
- "Nothing on the market comes close."
- "Nothing compares to the Schweiss design!"
- "Schweiss doors have no need for adjustments."
- "Keeps the overall building height down."
- "No lost height at the opening; doors open out!"
- "The grease zerks on their hinges are a home run."

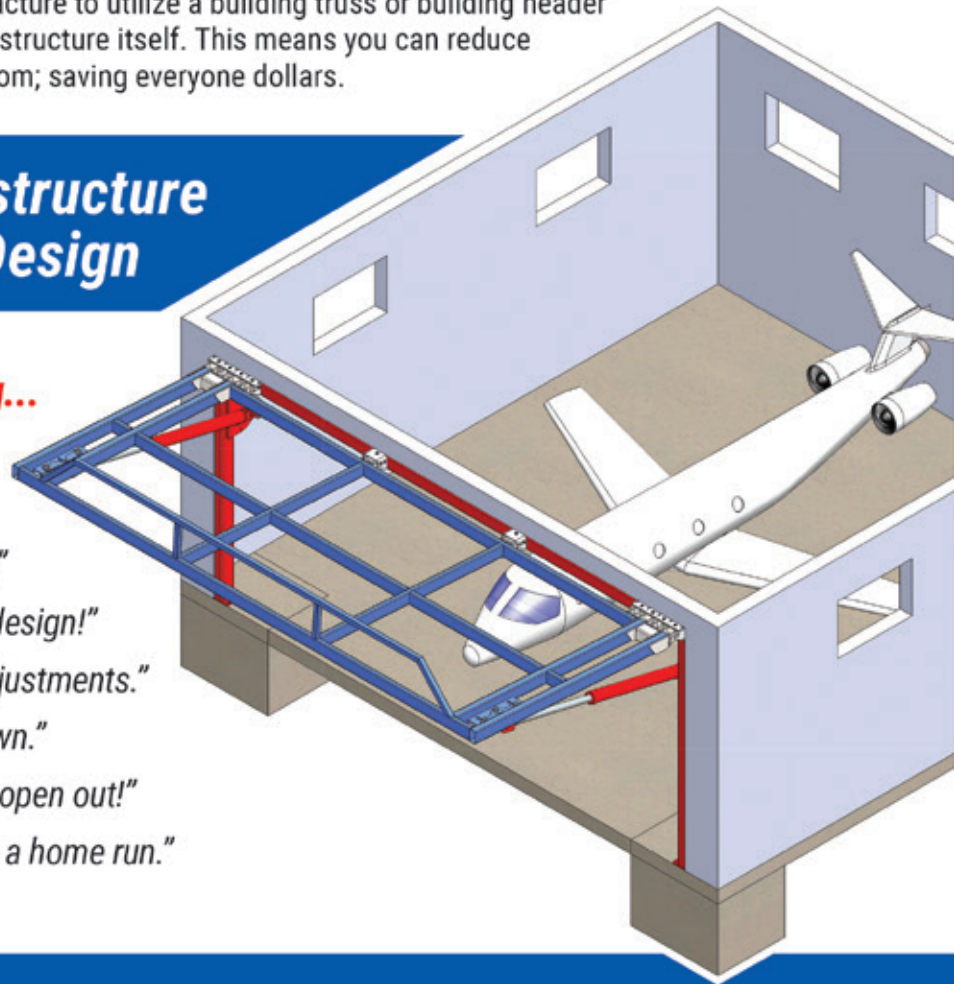

Hydraulic doors have **THREE** major components; the cylinders, the doorframe and the subframe header. The three major components are all connected together to form a solid triangle when the door is in any position. By connecting all the major components together it comprises a huge structural advantage and makes the door operation and installation strong and stable.

THREE . . . MAJOR COMPONENTS

1ST

Moving Doorframe And Hinges...

Connect to the overhead structural subframe – that includes a robust hinge design providing considerably greater surface area for distributing the load of the moving door evenly. The patented hinges include easy access greaseable lubrication zerks and removable hinge pins for extended service life.

2ND

Heavy-Duty Cylinders...

Support the sides and ends of the door in all positions. Spherical bearings connecting cylinders on each side of the door to the doorframe accommodate horizontal movement or deflection. They also allow for flexibility of the door and frame without binding on the cylinder pins and brackets.

3RD

Tripod Legs...

Attach to the Subframe Header providing the structural strength that carries the weight of a large moving doorframe! The Tripod structure supports the door and hydraulic cylinders eliminating column twist, distributing the door weight and loads evenly into the concrete footer – the door loads are transferred to the floor during operation, not the building.

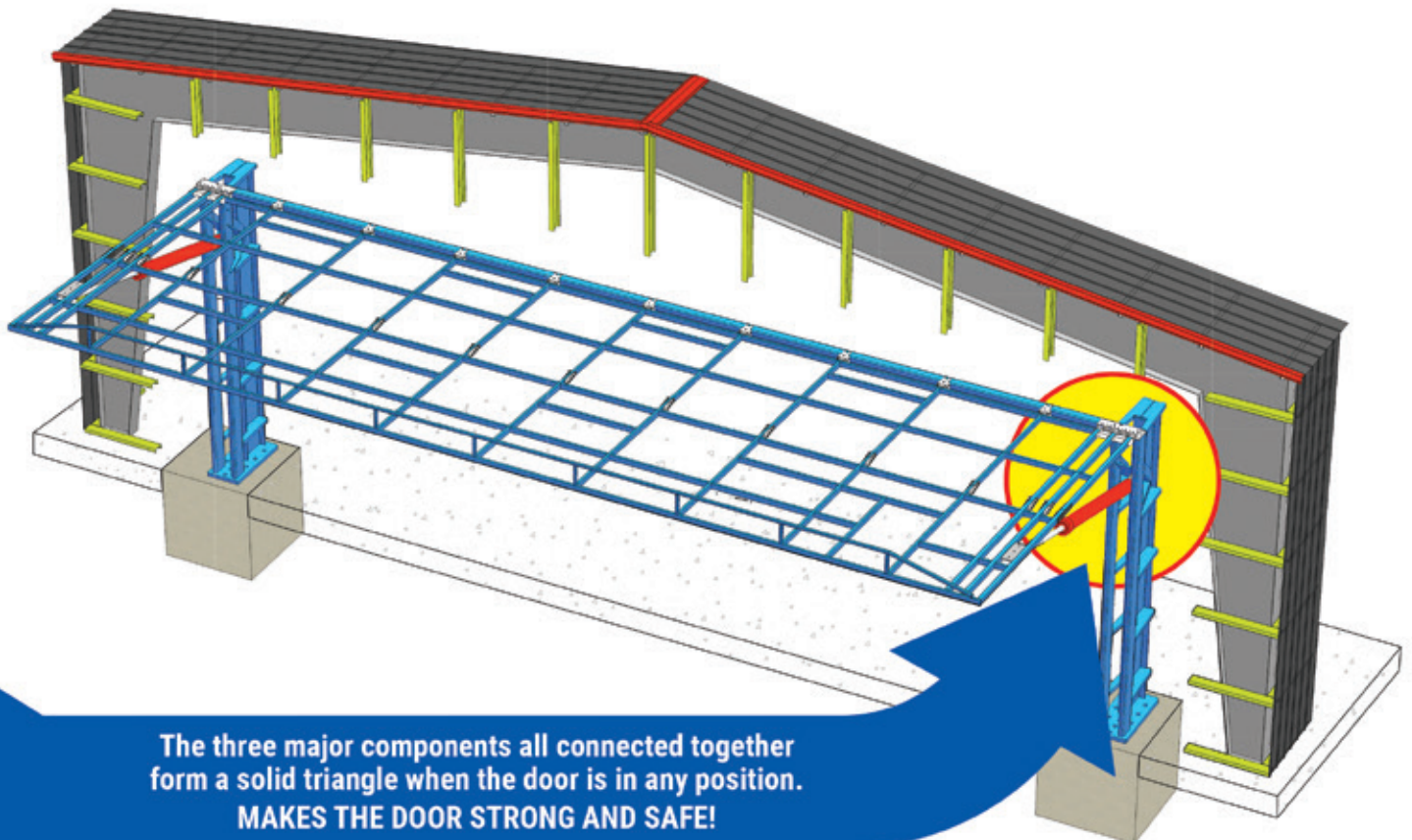

The three major components all connected together form a solid triangle when the door is in any position.
MAKES THE DOOR STRONG AND SAFE!

ADVANTAGES OF THE SUPERSTRUCTURE DOOR DESIGN **LOWER BUILDING COSTS**

The new leg design transfers the door weights to the footings that support the hydraulic door, eliminating the need for additional side columns from the building manufacturer.

Stand-Alone Door

SCHWEISS DOORS ARE ON THE LEADING EDGE OF HYDRAULIC DOOR INDUSTRY

Building costs are significantly reduced with our tripod leg design self-supported hydraulic door-frame. Schweiss is the leader in manufacturing hangar doors for general aviation and commercial jet hangars. Our self-supported hydraulic door is designed with a purpose and a clear objective. The self-supported design will benefit everybody from architects, engineers to building manufacturers, and more importantly will save money for the end-users of the doors.

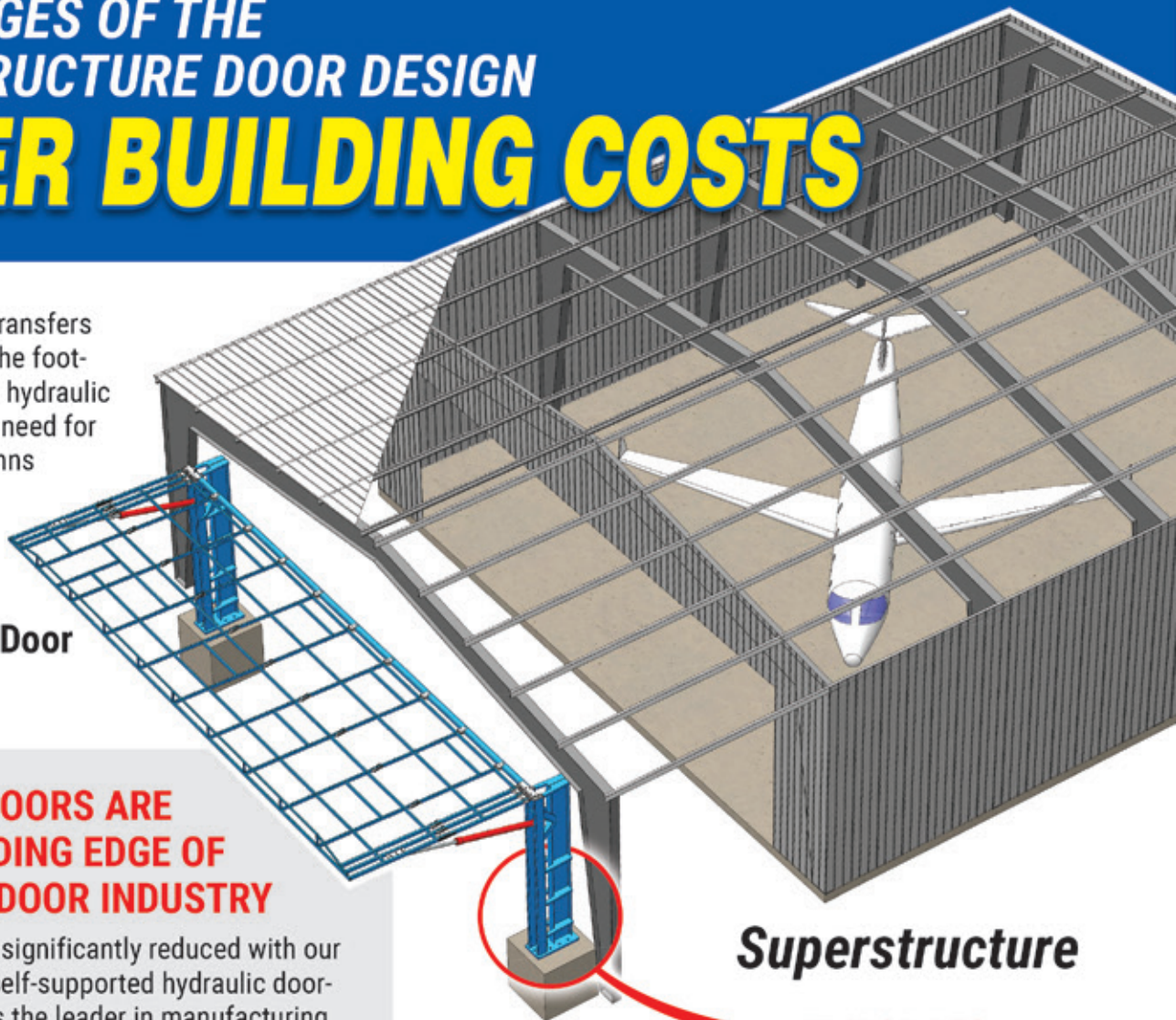

Superstructure

TRIPOD LEG

WHILE OTHER DOORS MAY APPEAR TO BE THE SAME ON THE SURFACE, THERE REALLY IS NO COMPARISON!

EACH DOOR COMES PRE-HUNG WITH ITS OWN FRAME

- Heavy-duty hinges are pre-welded to the doorframe and horizontal continuous member for ease of installation.
- Doors are pre-assembled, pre-welded and delivered pre-hung within a pre-squared frame. Each door is fully assembled from the factory, saving you hours of installation time. Compare this to tilt-up doors that are shipped out in a kit form that consists of many bolts, steel members, cables and other components that have to be field-assembled and be field-squared up at the job sight. Assembling a kit door takes more time to install!
- Makes installation easy; framework is standard on all Schweiss hydraulic doors – just lift the framework and door into place all in one step.

Schweiss has designed a new door model that makes other existing door models on the market obsolete!

NO WELDING NECESSARY

Schweiss door framework consists of a continuous header that's factory fitted to the tripod cylinder legs.

The doorframe is attached to the complete framework at the factory making installation easy.

The framework adds extra building support. Schweiss self-contained framework simplifies installation.

SELF-LATCHING

Self-Latching: Holds the door in place in the closed position ... never creeps open.

The hydraulic pump has a built-in positive-hold valve that maintains and keeps the door locked in the closed position! Hydraulic cylinders automatically pull the doors in tight against your building and will keep the door in a locked position that provides a tight seal.

SCHWEISS DOORS ARE POWERED UP & POWERED DOWN

Doors operate evenly in either direction secured by the heavy-duty hinges.

SUPERSTRUCTURE DOOR HAS ITS OWN SELF-SUPPORTING SUBFRAME

Schweiss hinges distribute the door loads evenly across the self-supporting subframe greatly reducing stress on the building structure.

1 Robust Hinge Advantages

Hydraulic doors have a huge advantage, by utilizing the major components for stability! The major components are all connected together to form a solid triangle when the door is in any position. By connecting all the major components together there's a huge structural advantage and more importantly it adds stability to the door at all positions and allows for flexibility of the door and frame without binding on the cylinder pins and brackets. With all the major components connected, it at all times makes the door operation and installation so much stronger and stable in all positions.

2 The Power Behind the Door

Heavy-duty cylinders are connected to the doorframe and massive tripod legs. They are supported by heavy-duty hinges that connect the doorframe to the subframe header to better support the moving doorframe in all positions. By connecting all the major components together it creates a huge structural advantage. A solid triangular connection gives a moving door support and accommodates horizontal movement or deflection to the moving doorframe in all positions, making the door operation and installation strong and stable.

3 "New Design" Stand-Alone Hangar Door

Tri-Pod Leg Design - We at Schweiss Hydraulic Doors are the only manufacturer of the Triple-Leg Stand-Alone Hangar Door. This innovative hydraulic door is the only one of its kind. We have taken our existing proven hydraulic door and now have even made it better! Schweiss is known for perfecting and developing better designed doors, and we have outdone ourselves again!

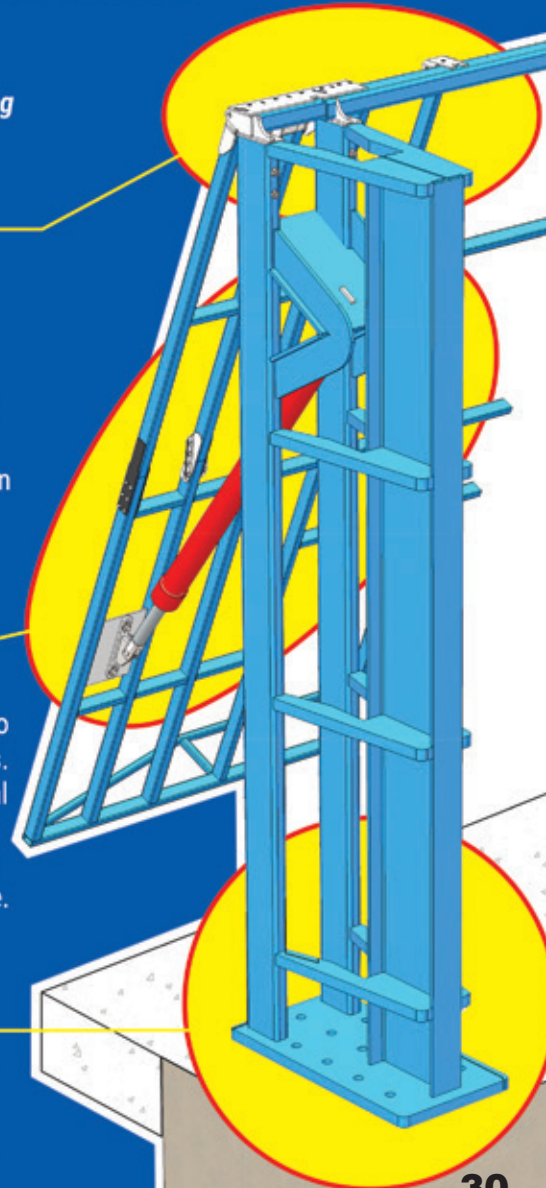

SCHWEISS CUSTOMER

DESIGNER DOOR PHOTOS

Golden 1 Center Strap Bifold Doors, Sacramento, CA



Testimonial

"Our decision wasn't based on price, we didn't even look at any other manufacturers doors. The doors always work, there hasn't been any maintenance on them. We haven't done a darn thing to them, just hit the button and they work."

Josh Kubesh

Testimonial

"Those sliding doors are a waste of time and money, you might as well spend a little extra right of the bat and do it right."

Fran Rosenquist



Marthas Vineyard Hydraulic Door



Under Armour Storefront Hydraulic Door, MD

Testimonial

"The design of the door is to extend our lobby outside to a huge patio area that will have umbrellas, tables, chairs, firepits – it's a big gathering area for our people."

Pastor Mark Slinger, CA

Cape Canaveral, Florida Strap Bifold Door



Testimonial

"I can tell you one thing, if we ever have to replace any other doors, it will be with a Schweiss door and not any other brand door; there is no doubt about it."

George Happ, Utah

Testimonial

"Schweiss Designer Doors offer architects many design options. I'd like to see architects consult with Schweiss Doors to learn more about their products and options available,"

Bill Schmidt, CA

RV Garage Bifold Door, WA



RV Garage Hydraulic Door, NC



Testimonial

The door opens reasonably fast, it's quiet, seals well and the quality and workmanship is excellent. You're putting a door on that is built to last 50 years or more."

Gary Seehusen

New Market, Ontario Glass Bifold Doors



MORE

DESIGNER DOOR PHOTOS

Fermilab, Batavia, Illinois



ICA Water Shed, Boston, Massachusetts



Sam's Tavern, Seattle, Washington



Yankee Stadium, New York City, New York



Coffee Shop, San Francisco, California



Carriage House, Cornelius, North Carolina



MN State Fair, Falcon Heights, Minnesota



BPA Maintenance Bldg., Southwest Washington



Tin Can Project, Los Angeles, California



Barrel & Bushel, Tysons Corner, Virginia



YOU THINK IT . . . WE BUILD IT!

SCHWEISS **QUALITY**

HYDRAULIC DOORS

- Farm Doors
- Barn Doors
- Commercial Doors
- Designer Glass Doors
- Airplane Hangar Doors

BIFOLD DOORS